



INSTRUCTIONS

BELT UP BABY® **INFANT RESTRAINT SYSTEM** **FOR INFANTS 9 MONTHS OR OLDER**

IMPORTANT:

BELT UP BABY® INFANT RESTRAINT SYSTEM is not a replacement for a infant seat and should only be used when one is not available and not required by law

CONTENTS

- Page 3** **Important safety information -
PLEASE READ**
- Page 4** **Out of the box**
Identify the parts of the Belt Up Baby®
- Page 5** **Before usage and fitting**
What to do before using Belt Up Baby® for
the first time
- Page 6** **Before entering the vehicle**
- Page 7** **Fitting with lap and diagonal strap seat belt**
- Page 9** **Securing your infant with Belt Up Baby®**

IMPORTANT SAFETY INFORMATION - PLEASE READ

- Please read all the instructions in this guide and make sure that you fully understand how to use the Belt Up Baby® before using it for the first time with your infant.
- Keep these instructions for future reference.
- Do not alter or modify the Belt Up Baby® in any way.
- Do not fit the Belt Up Baby® on side or rear facing vehicle seats.
- Belt Up Baby® is not recommended for infants less than 9 months old.
- When both occupants are fully installed in the car the top of the infant's head should not be higher than the bottom of the adult's nose.
- Belt Up Baby® should not be used in the front seats of a car.
- Never buy a second-hand Belt Up Baby® infant restraint system.
- After an accident always replace the Belt Up Baby® with a new one - even if it looks undamaged, there might be unseen damage which could make it potentially dangerous.
- If the Belt Up Baby® is left in direct sunlight the plastic and metal parts could become very hot and can cause burns. Please cover up Belt Up Baby® or store it out of sunlight.
- Belt Up Baby® is only suitable for use with 3-point lap and diagonal strap seat belts. Do not use with a lap only seat belt.
- When in use the adult seat belt must remain flat and untwisted.
- Always check that no parts of the Belt Up Baby® become trapped in the car doors.
- Regularly examine the Belt Up Baby® for wear and tear, if there is any damage that could compromise the safety of the restraint system a new device should be used.
- Store Belt Up Baby® in a dry environment when not in use.
- Clean all Belt Up Baby® parts with cool or warm water and a soft cloth. Do not use hot water.

OUT OF THE BOX

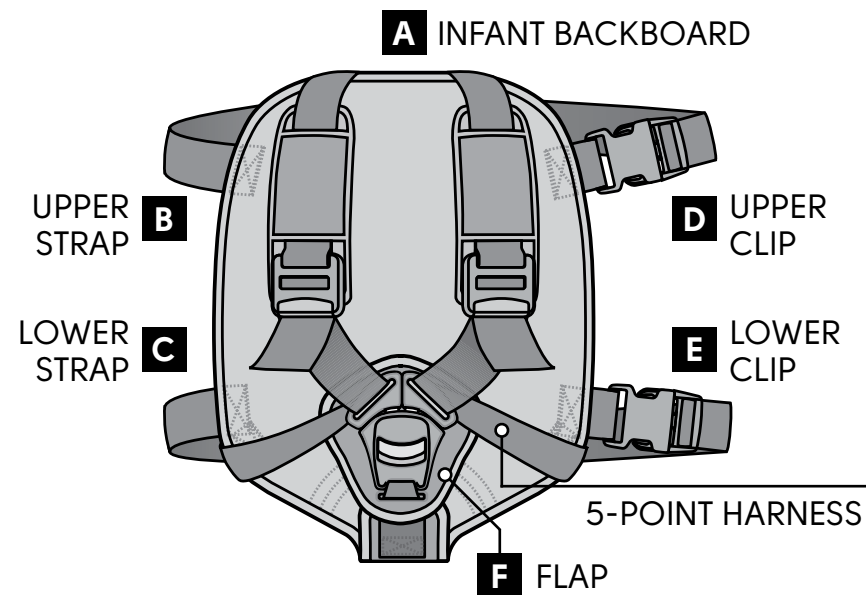

BEFORE USAGE AND FITTING

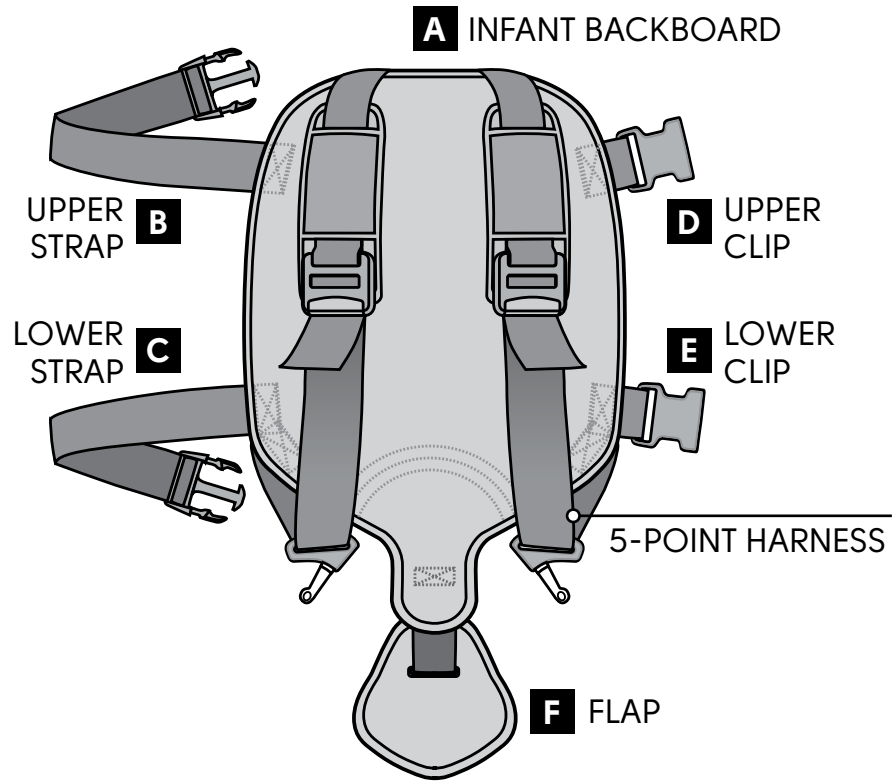

Loosen all straps 'B' and 'C' - and those on the 5-point infant harness.

BEFORE ENTERING THE VEHICLE

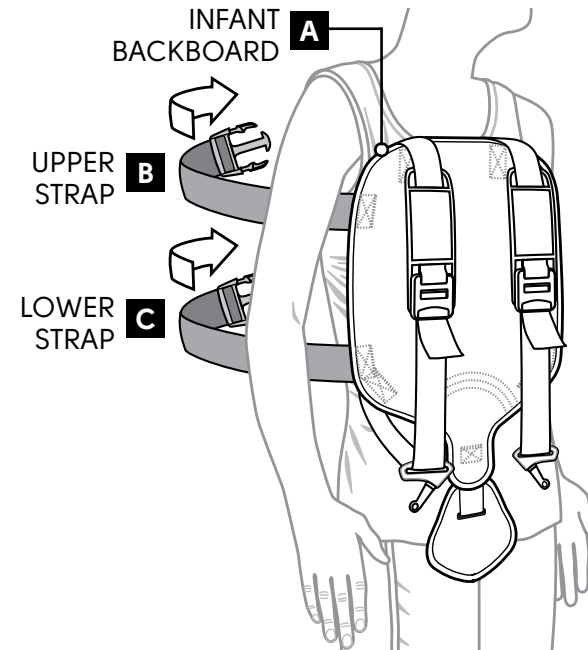

STEP 1

Before entering the vehicle, place infant backboard 'A' against chest and pass upper strap 'B' and lower strap 'C' around the back of the adult.

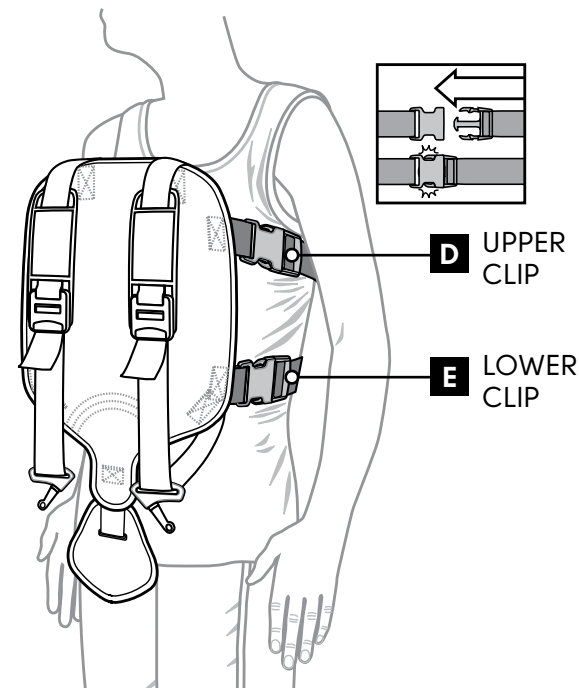

STEP 2

Fasten upper strap 'B' into upper clip 'D' and lower strap 'C' into lower clip 'E' and tighten so that straps are secure but comfortable.

FITTING WITH LAP AND DIAGONAL STRAP SEAT BELT

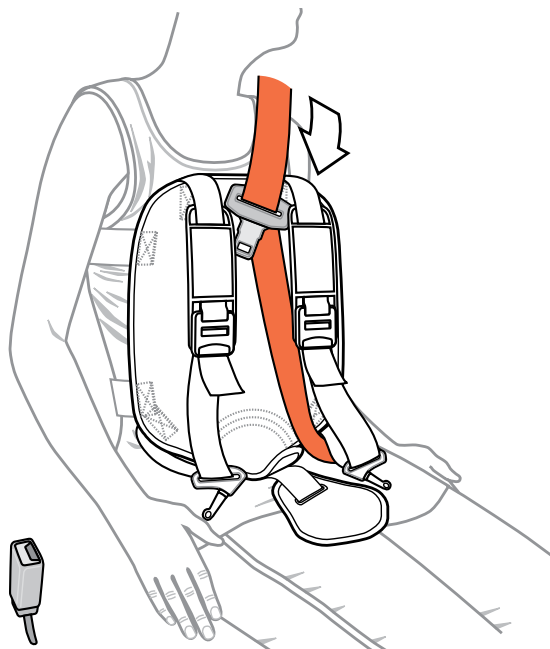

STEP 3

Once sat in the vehicle, fasten the adult seat belt around first infant harness strap (closest to the car door).

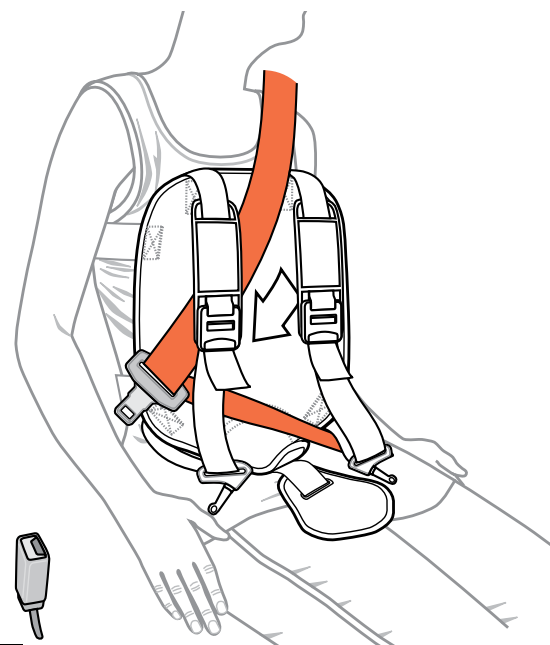

STEP 4

Then pass the seat belt diagonally through the second infant harness (closest to the vehicle seat belt receptacle) ensuring that the adult lap strap lies under the first infant harness (the one closest to the car door).

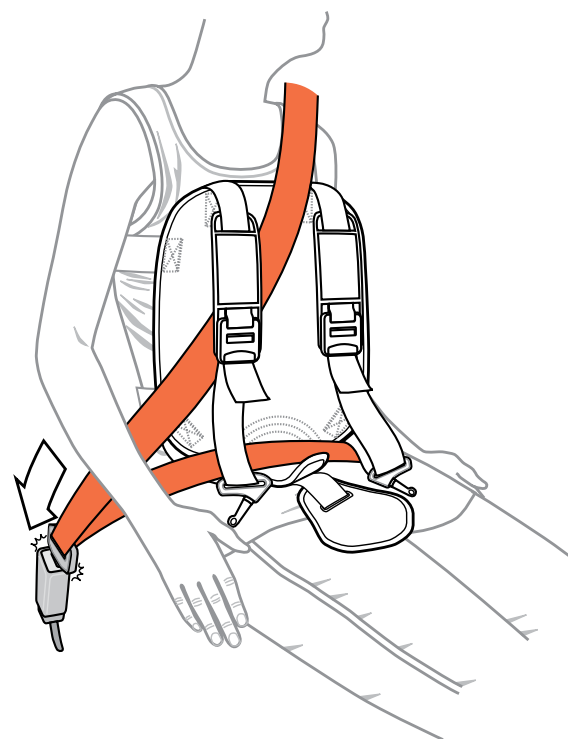

STEP 5

Fasten seat belt into receptacle. Ensure seat belt is not obstructed so that diagonal belt is free flowing between shoulder straps of harness and pelvic strap is on adult pelvis.

IMPORTANT!

DO NOT USE THE BELT UP BABY® INFANT RESTRAINT SYSTEM WITH A LAP ONLY SEAT BELT

SECURING YOUR INFANT WITH BELT UP BABY®

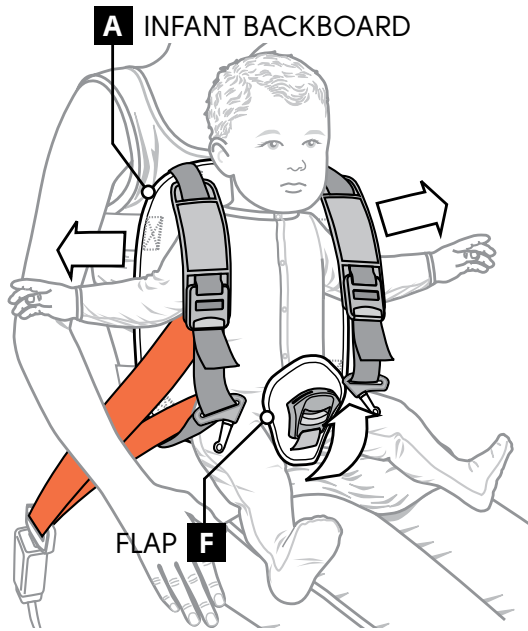

STEP 6

Place infant on adult lap against infant backboard 'A' and lift up flap 'F'. Place the infant's arms through the shoulder straps of the 5-point infant harness.



STEP 7

Fasten the 5-point infant harness, tighten the straps so that the infant is secure but comfortable and then adjust the pads to protect the infant's shoulders.



BELT UP BABY®
INFANT RESTRAINT SYSTEM